

THERMOSTATIC MIXING VALVES

ECO-MIX™ LV-981A-LF-_____ 2.5-43 GPM (9-163 l/min)

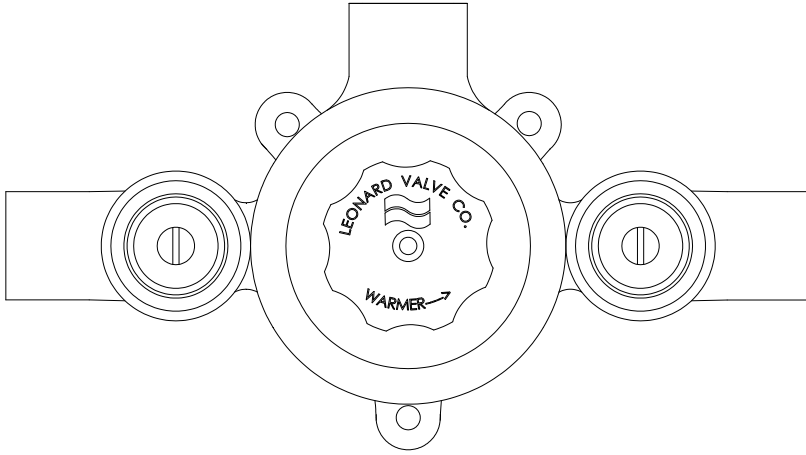

This product is certified to meet Low Lead requirements of wetted surface area containing less than 0.25% lead by weight

- Thermostatic Water Mixing Valve with 2.5 GPM (9.0 l/min) minimum flow capacity +
- 3/4" inlets, 3/4" outlet (19mm x 19mm) sweat connections ONLY
- Integral combination check stops with wall support
- 125 PSI (8.6 BAR) maximum operating pressure
- Copper encapsulated thermostatic assembly with stainless steel shuttle
- Temperature adjustment range, 90-140°F (32-60°C) **
- Locking temperature regulating handle
- Internal parts of LF bronze, stainless steel
- Rough Bronze Finish

SYSTEM PRESSURE DROP										
MIN. FLOW	5	10	15	20	25	30	35	40	45	PSI
	0.3	0.7	1	1.4	1.7	2.1	2.4	2.8	3.1	BAR
2.5	14	20	24	28	32	35	38	41	43	GPM
9	53	76	91	106	121	132	144	155	163	l/min

OPTIONS

___ SUFFIX **IT** Inlet thermometers (shipped loose)

___ SUFFIX **LWS** Less wall support

___ SUFFIX **BDT** Ball valve with dial thermometer (shipped loose)

___ SUFFIX **TH** – Threaded inlets / outlet, female NPT, see page 2

NOTE: CP Chrome plated is NOT AVAILABLE

ASSE 1017 Certified



cUPC Certified

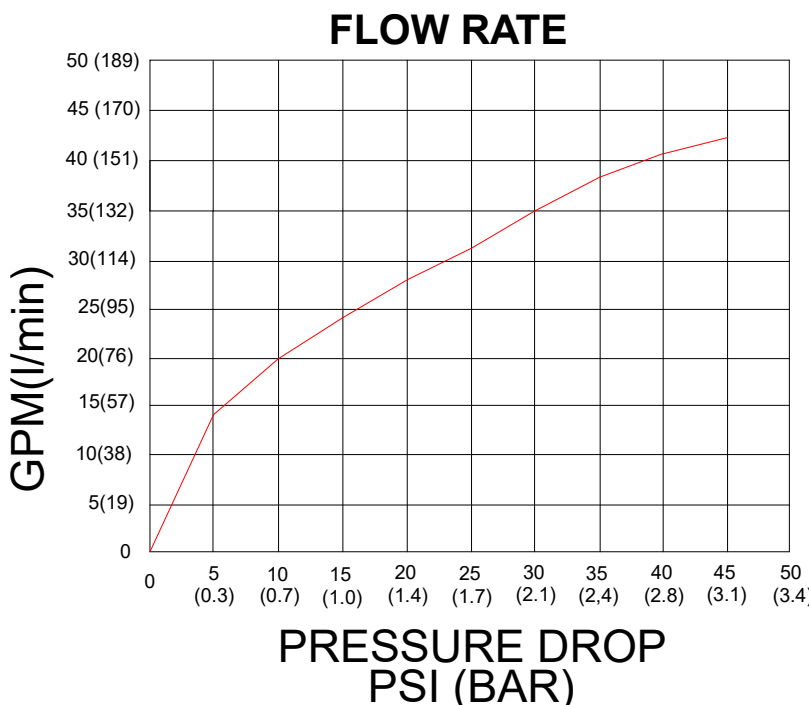

WARNING: This product can expose you to chemicals including lead, which is known to the State of California to cause cancer. For more information, go to www.P65Warnings.Ca.gov

+NOTE: The valve will maintain temperature with 0.5 GPM flow from the domestic hot water loop when properly installed near the hot water source with a continuously operating recirculation pump.

***NOTE:** A locking temperature regulator is simply a mechanical setting to prevent unauthorized temperature set point changes. AFTER INSTALLATION THE VALVE MUST BE RESET BY THE INSTALLER !!

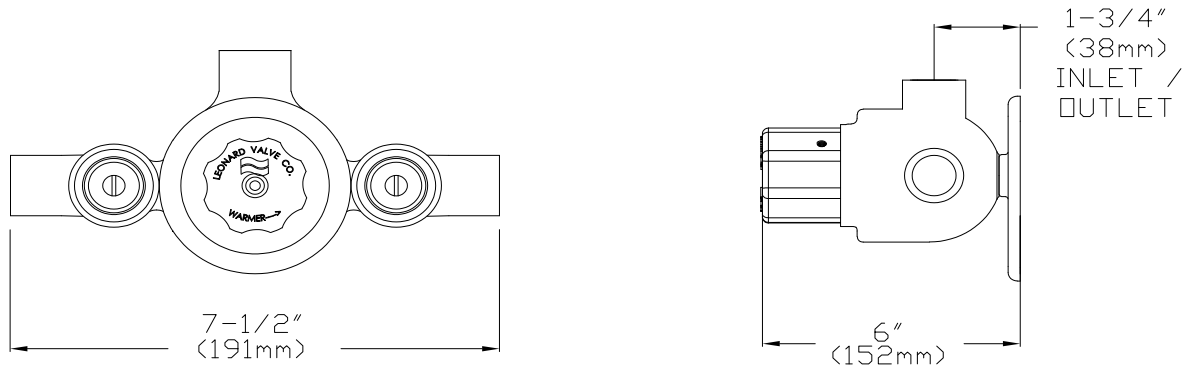

SUFFIX TH

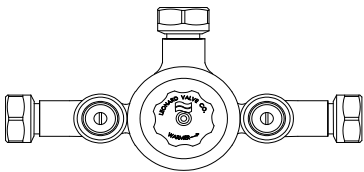

SUFFIX BDT, PARTS SHIPPED LOOSE

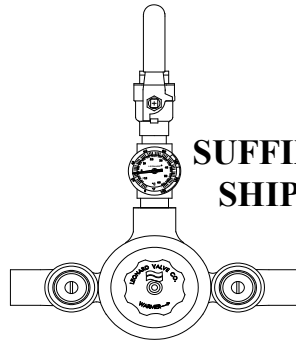

SUFFIX IT, PARTS SHIPPED LOOSE

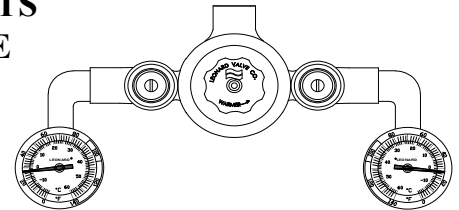

HIGH TEMPERATURE FIXTURES (IF APPLICABLE)

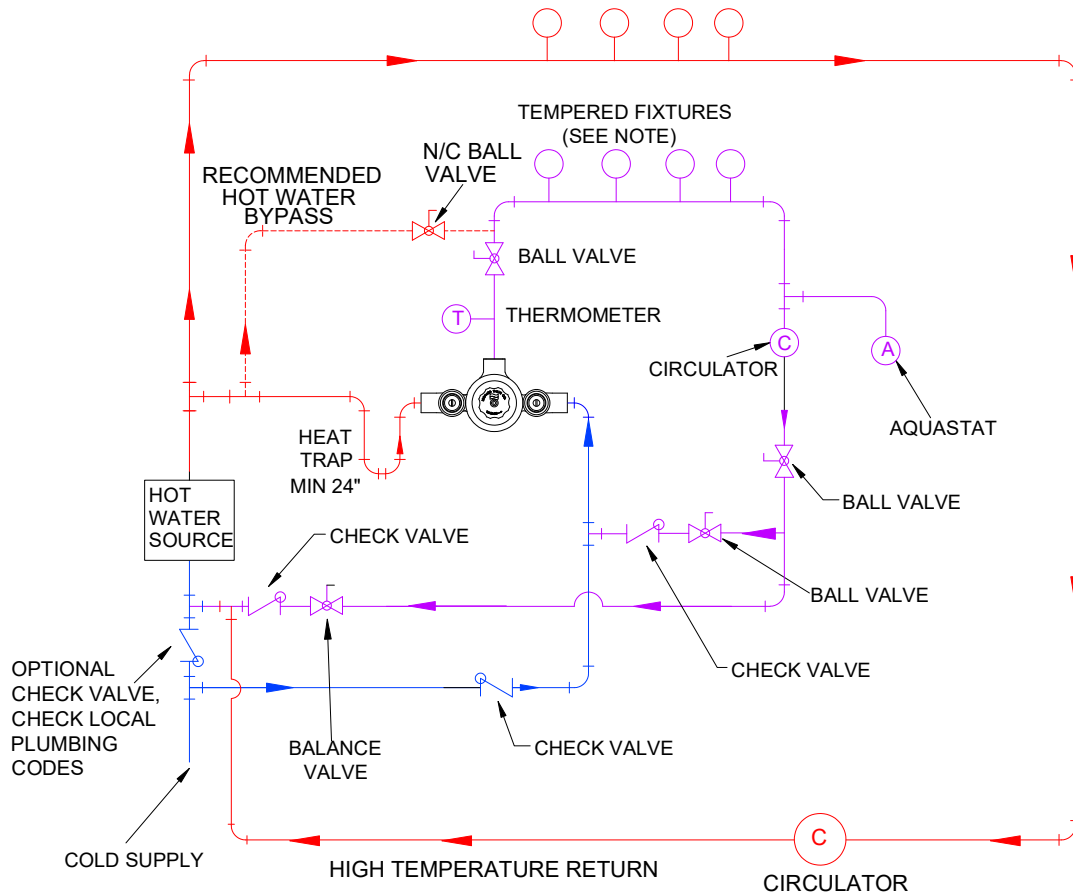

Engineer's Approval	Job # _____
	Arch/Eng. _____
	Contractor _____

NOTE: Leonard Valve Company reserves the right of product or design modification without notice or obligation



1360 Elmwood Avenue, Cranston, RI 02910 USA

Phone: 401.461.1200 Fax: 401.941.5310

Email: info@leonardvalve.com

Web Site: <http://www.leonardvalve.com>

CAUTION! All thermostatic water mixing valves have limitations. They will NOT provide the desired accuracy outside of their flow capacity range. Consult the Flow Capacity Chart and DO NOT OVERSIZE. Minimum flow must be no less than as indicated.