

# COMPLETE WATER TEMPERATURE CONTROL STATION

## \* LEAD FREE MEGATRON® MODEL XL200-SW-LF

- 2" HOT & COLD INLETS
- 2" MIXED OUTLET
- 1-1/4" RETURN PIPING
- 5 to 208 GPM (19 to 787 l/min)

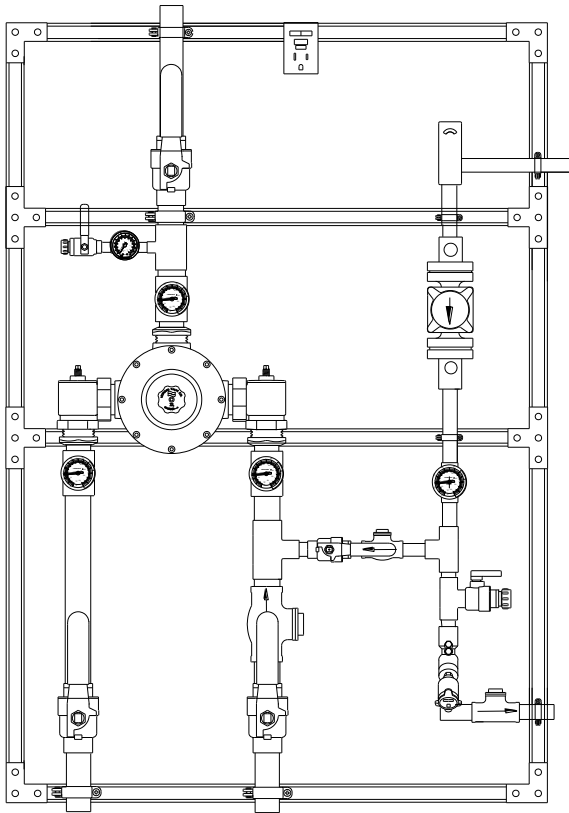

See page 2 for  
Specification detail

See page 3 for  
Drawing detail

See page 4 for  
Flow capacity chart

See page 5 for Options

ASSE 1017 Certified



cUPC Certified



Valve assembly is certified to meet Low-Lead requirements of wetted surface area containing less than 0.25% lead by weight. All other fittings and components, the sum total of which comprise the wetted surface of this product contains less than one quarter of one percent of lead by weight.



**WARNING:** This product can expose you to chemicals including lead, which is known to the State of California to cause cancer. For more information, go to [www.P65Warnings.Ca.gov](http://www.P65Warnings.Ca.gov)

<b>Engineer's Approval</b>	Job # _____
	Arch/Eng. _____
	Contractor _____
<p>Note: The models shown represent Leonard Products which are believed to be equivalent in type and function to items specified. Leonard Valve Company is not responsible for errors or omissions due to differences in interpretations of information provided.</p>	

Product is non-cancellable and non-returnable from date from order with factory. Signed submittal required with purchase order.



1360 Elmwood Avenue, Cranston, RI 02910 USA

Phone: 401.461.1200 Fax: 401.941.5310

Email: [info@leonardvalve.com](mailto:info@leonardvalve.com)

Web Site: <http://www.leonardvalve.com>

# MEGATRON® MODEL XL200-SW-LF

LEONARD MEGATRON® MODEL XL200 LF Complete Water Temperature Control Station (5-208 GPM, 19 to 787 l/min) to include:

- 2” bottom inlet connections (copper tube)
- 2” top outlet connection (copper tube)
- 1-1/4” return line size with piping method #W
- Copper encapsulated thermostatic assembly with Teflon coated shuttle
- Locking temperature regulating handle set for 120°F (49°C)
- Temperature adjustment range, 95-135°F (35-57°C) \*\*
- Full port ball valve, pressure gauge on mixed water outlet piping of mixing valve.
- Dial thermometer (0 to 140°F, -10 to 60°C) and pressure gauge on mixed water outlet of the system.
- Outlet Test Connection with ball valve and 3/4” hose connection with cap
- Full port ball valve mounted downstream of test connection on mixed water outlet of the system
- Inlet piping manifold with full port ball valves and dial thermometers (20 to 240°F, -7 to 116°C on hot supply, 0 to 140°F, -10 to 60°C on cold supply) on hot and cold supply inlets
- Return piping, 1-1/4”, with aquastat, circulator, dial thermometer (0 to 140°F, -10 to 60°C), ARV valve to balance system, and check valve
- Aquastat with temperature differential of 5 to 30°F (3 to 17°C)
- GFCI\* switch. The GFCI switch will be used to turn the circulator on or off for setup. \*Ground Fault Interrupter
- Bypass piping, 1-1/4”, with check valve and isolation ball valve to cold inlet of mixing valve
- Maximum operating pressure: 125 PSIG (860KPA)
- System mounted on strut, galvanized. Strut shall be assembled with three hole flat angle plate on corners, four hole tee plates or two hole flat plate connectors on all other support pieces using 3/8” grip lock nuts and 3/8”x 1” hex head cap screws, washers and lock washers.
- Factory pre-assembled and tested as a complete system
- All electrical connections to be completed by Electrical Contractor
- Taco 0013 standard pump included and installed
- Optional Taco smart pump, 0034E PLUS, see options page for more info

**\*\*NOTE:** For temperatures outside of this valve’s stated range, please see our line of bi-metal valves.

# MEGATRON® MODEL XL200-SW-LF

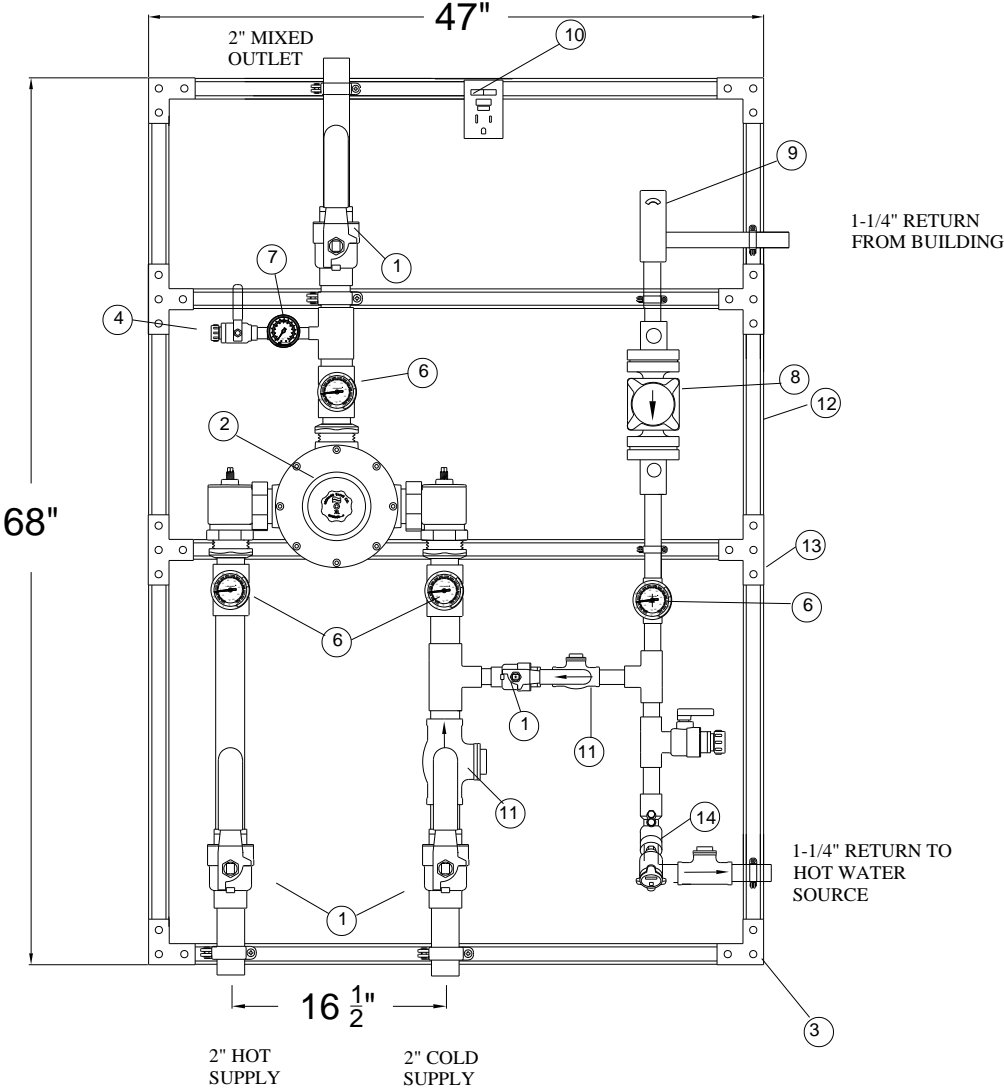

Dimensions may vary with the addition of options see page #5

### LEGEND

1.	Full port ball valve	6.	Dial thermometer	11.	Flapper check
2.	Mixing valve	7.	Pressure gauge	12.	Galvanized Strut
3.	Corner Bracket	8.	Circulator-As specified by Engineer	13.	Tee bracket
4.	Test connection	9.	Aquastat		
5.	Balancing Valve	10.	Circulator power switch		

# MEGATRON® MODEL XL200-SW-LF (5 TO 208 GPM)

## Flow Capacity

PRESSURE DROP											
MIN+ FLOW	5	10	15	20	25	30	35	40	45	50	PSI
	0.3	0.7	1	1.4	1.7	2.1	2.4	2.8	3.1	3.4	BAR
5	69	96	117	135	148	163	174	188	198	208	GPM
18.9	216	363	443	511	560	617	659	712	750	787	l/min

+NOTE: The valve will maintain temperature with 0.5GPM flow from the domestic hot water loop when properly installed near the hot water source with a continuously operating recirculation pump.

NOTE: Flowrates will vary depending on existing field conditions. Leonard Valve Company always recommends using CASPAK® sizing software for proper valve sizing and model number applications.

Note: The XL200 LF model must be selected based upon the following:

Maximum system demand for mixed water

System pressure drop\*

Designer's estimated minimum mixed water flow requirement

\*System pressure drop= the pressure available at the inlet of the mixing valve unit minus the pressure required to operate the farthest fixture, i, e., Shower valves, in the building.

**Consult local national codes: conformity and compliance to local and national codes is the responsibility of the installer.**

### EXTENDED THERMOSTAT WARRANTY

Call the factory at 1-800-222-1208 for details on Leonard's exclusive Extended Limited Warranty for High Low System Thermostats. Note! Specifications are subject to change without notice!!!!

# OPTIONS

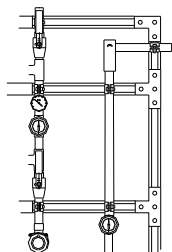

**LC**

Megatron® furnished without a circulator.

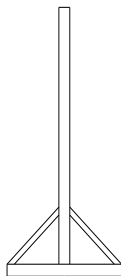

**FM**

Megatron® with 3 legs, 3 ½” feet and 45 degree braces front and back for mounting to floor in center of room.

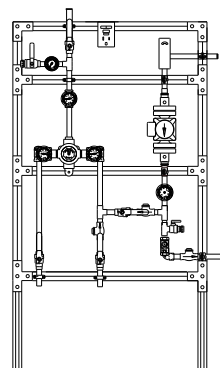

**FS**

Megatron® with legs to floor (shipped separate) to support the unit without hangers.

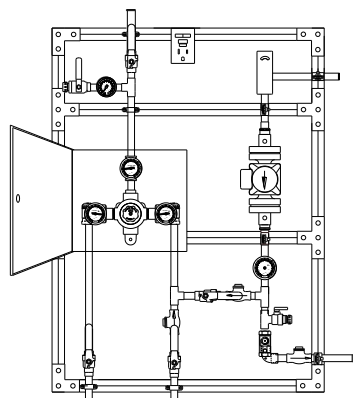

**CAB**

Megatron® with SS cabinet around mixing valve

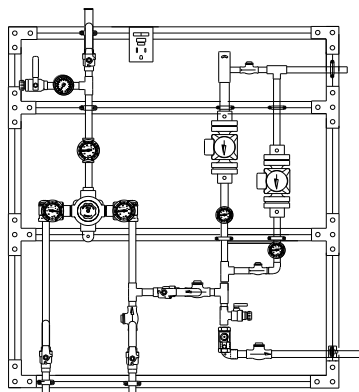

**2 PUMPS R**

Redundant recirculation pump

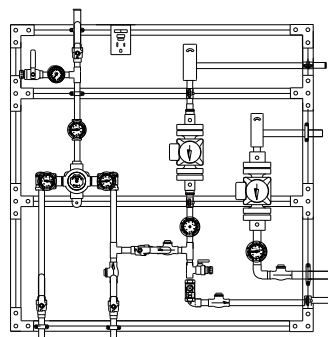

**2 PUMPS H**

High temperature loop recirculation pump

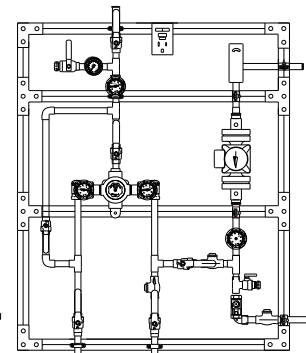

**HBP**

High temperature by-pass flush with locking ball valve

## OPTIONS \*

- LC** Less circulator
- FM** Floor mount
- FS** Free standing
- CAB** Cabinet around mixing valve
- 2 PUMP R** Redundant recirculator pump
- 2 PUMP H** High temperature loop recirculator pump
- HBP** High temperature by-pass flush
- 265-1** Timer, Analog, 24 hour
- 265-3** Timer, Digital, 7 day
- HOA** HOA switch

## OPTIONS (shown on next page) \*

- AL** Audio Visual Alarm
- RDU** Remote Display Unit
- LMS-188-4P** Leonard Monitoring system
- LMS-188-4P-BMS** with BMS
- DA** Digital Aquastat
- DG** Digital Gauges
- TACO 0034EPLUS** Smart pump
- D01** Digital Package, Aquastat, Gauges and Digital pump
- User chosen pump** (specify on next page)

## PIPING OPTIONS \*

- RP 1-1/2** 1-1/2” Return line size
- RP 2** 2” Return line size

\* Any option chosen will alter pricing



### OPTION AL: Leonard Single Probe Digital Temperature Alarm

- Single Point Temperature Probe - Range: -148°F to 212°F Resolution: 1°F
- User adjustable high & low set points and initial alarm delay period
- Audible & visual alarms
- Remote alarm contacts (SPDT) with adjustable relay delay period
- AL option replaces analog outlet dial thermometer with a single digital display



### OPTION RDU: Leonard Remote Display Unit

- Activation by Primary Alarm's (pictured above) remote alarm contacts
- Alarm Delay Module with yellow, red, green LED indicators
- Recommended maximum distance from controller to RDU is 500'

### OPTION LMS-188-4P: Leonard 4 Point Digital Monitoring with Alarm

- Four (4) Temperature Probes - Range: -148°F to 212°F Resolution: 1°F
- User adjustable high & low set points and initial alarm delay period
- Audible & visual alarms
- Remote alarm contacts (SPDT) with adjustable relay delay period
- 10/100 Ethernet Connection
- Web Server Interface for Setup & Commissioning
- Unit can send an E-mail transmission of alarms for up to 8 contacts
- Unit can send an E-mail report daily with temperatures readings over the previous day
- LMS-188-4P option replaces analog dial thermometers with a single digital display for all 4 temperatures, incoming hot, incoming cold, outlet and return

### OPTION LMS-188-4P-BMS: Leonard 4 Point Digital Monitoring System with Alarm & Enhanced Protocol Communication Interface Module

#### Primary Alarm Box includes:

- Same as above

#### ProtoNode Accessory Box includes:

- Interface Module to connect LMS-188-4P-BMS to Building Management System (-BMS) Network, Complete Protocol Package
- Supported protocols include BACnet MS/TP, BACnet IP, Modbus RTU, Modbus TCP/IP, SNMP, JC N2, available simply by selecting the proper DIP switches
- Cat 5 Ethernet Cable not included
- LMS-188-4P-BMS option replaces analog dial thermometers with a single digital display for all 4 temperatures, incoming hot, incoming cold, outlet and return

### OPTION TACO 0034E PLUS: ECM High-Efficiency Circulator

- High-performance, variable speed, wet-rotor circulator with high-efficiency ECM permanent magnet technology, Simple 3-button control
- An intuitive digital user interface lets you choose between a variety of operating modes; activeADAPT™, five Constant Pressure curves, five Proportional Pressure curves, Min/Max fixed speed or speed control through 0-10V DC or PWM external input
- Digital LED screen displays; Watts, GPM, Head, RPM and diagnostic error codes
- Maximums of 34 feet of head and 50 GPM

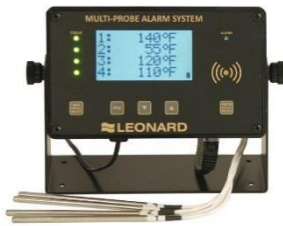

OPTION



### USER CHOSEN PUMP

Standard pump is TACO 0013, if another manufacturer is preferred please specify, but note that ANY change from standard pump will result in a **PRICE INCREASE**

1360 Elmwood Avenue, Cranston, RI 02910 USA

Phone: 401.461.1200 Fax: 401.941.5310

Email: [info@leonardvalve.com](mailto:info@leonardvalve.com)

Web Site: <http://www.leonardvalve.com>