

INSTALLATION ADJUSTMENT SERVICE NEXT-GENERATION MANIFOLD SYSTEMS TM-520B-LF , TM-820B-LF, TM-920B-LF, TM-1520B-LF

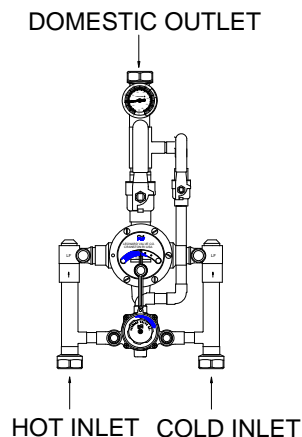

WARNING: This product can expose you to chemicals including lead, which is known to the State of California to cause cancer. For more information, go to www.P65Warnings.Ca.gov

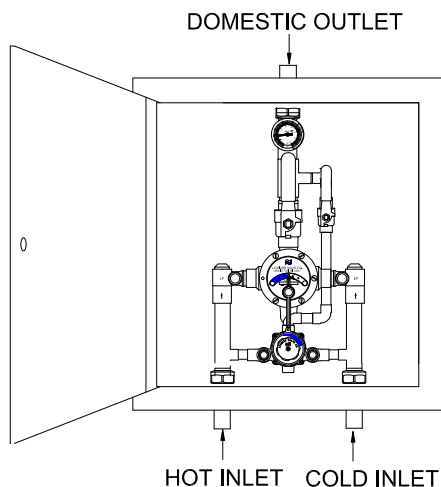

INSTALLATION

<ol style="list-style-type: none"> 1. Type TM manifold systems are factory pre-assembled and tested and include large and small thermostatic water mixing valves which function as a system to meet both high and low demand for tempered water. 2. System should be installed at a location where it can easily be cleaned, adjusted or repaired. 3. System supplies must be connected as shown (Hot-left, Cold-right). Exercise caution when soldering. 	<ol style="list-style-type: none"> 4. Flush pipes thoroughly after system has been connected. 5. If this assembly is installed on a recirculated hot water system it MUST be piped according to correct piping method see pages (4 & 5). 6. Refer to page 3 of this bulletin for correct Setup instructions.
--	--

Maximum Operating Pressure 125 PSI (860 KPA) for Hot and Cold Water.

CAUTION

All thermostatic water mixing valves have limitations. They will not provide the desired accuracy outside of their flow capacity range. Consult the capacity chart on page 9. Minimum flow must be no less than as shown.

REMEMBER! THIS IS A CONTROL SYSTEM WHICH MUST BE CLEANED AND MAINTAINED ON A REGULAR BASIS (SEE MAINTENANCE GUIDE AND RECORD MGR-1000).

1360 Elmwood Avenue, Cranston, RI 02910 USA
Phone: 401.461.1200 Fax: 401.941.5310
Email: info@leonardvalve.com
Web Site: <http://www.leonardvalve.com>

ADJUSTMENT AND SERVICE

Leonard Type TM Thermostatic Water Mixing Valves are simple in design and may be easily cleaned, adjusted and repaired. If the installation is accessible, servicing may be completed without disconnecting the valves.

NOTE: High Low Manifold Systems include Thermostatic Water Mixing Valves, which must be regularly maintained to provide best performance. Frequency of cleaning depends on quality of local water conditions and usage. See Maintenance Guide and Record MGR-1000.

WARNING

These mixing valves are equipped with an adjustable high temperature limit stop factory set at approximately 120°F (49°C) with an incoming hot water supply temperature of 150°F (65.5°C). If the hot water supply temperature of the job is greater than 150°F (65.5°C), the valves when turned to full HOT will deliver water in excess of 120°F (49°C) and the limit stops **MUST BE RESET BY THE INSTALLER!**

TO RESET ADJUSTABLE HIGH TEMPERATURE LIMIT STOP:

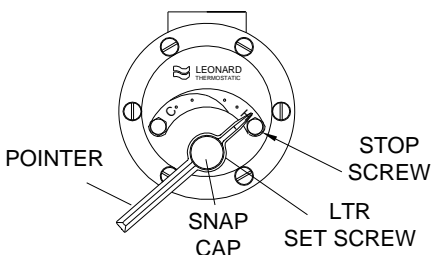
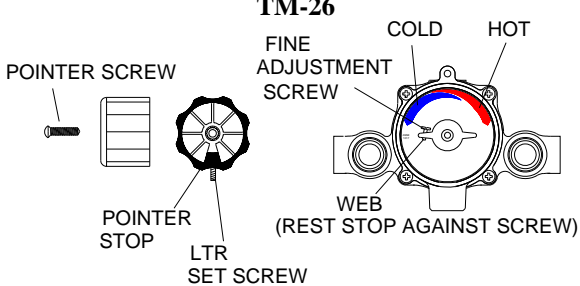
<p>Serial# s starting with 52, 82, 92, 152</p>  <ol style="list-style-type: none"> 1. Loosen LTR set screw. 2. Remove SNAP CAP, SCREW & WASHER. Remove POINTER. 3. Temporarily place POINTER on the spline rod, turn RIGHT for warmer temperature, turn LEFT for cooler temperature. When valve is delivering warmest temperature desired, remove the pointer. 4. Replace POINTER on the spline rod so that its RIGHT edge is resting against the STOP SCREW located on the RIGHT SIDE OF THE COVER. 5. The new maximum temperature has now been set. Test this temperature by holding a thermometer under the flow of water to be certain it is as desired. <p>* LIMIT STOP MUST BE RESET AND RECHECKED EACH TIME HANDLE IS REMOVED.</p>	<p>TM-26</p>  <ol style="list-style-type: none"> 1. Loosen LTR SET SCREW, remove POINTER SCREW. 2. Adjust POINTER to maximum desired temperature. 3. Remove POINTER, replace POINTER on spline rod with STOP (which is cast into the underside on the pointer), resting against the BOTTOM side of the WEB on the FINE ADJUSTMENT SCREW. 4. If fine adjustment is needed, adjust FINE ADJUSTMENT SCREW on the cover, loosen for hotter or tighten for cooler temperature. 5. Replace POINTER and check temperature, if set to desired temperature replace POINTER SCREW, and tighten LTR SET SCREW. 6. The new maximum temperature has now been set. Test this temperature by holding a thermometer under the flow of water to be certain it is as desired. <p>* LIMIT STOP MUST BE RESET AND RECHECKED EACH TIME HANDLE IS REMOVED.</p>
--	--

IMPORTANT! BOTH MIXING VALVES MUST BE SET AT THE SAME OPERATING TEMPERATURE.

SEE PAGES: 7 & 8 FOR COMPLETE PARTS BREAKDOWN

Check for significant variations in outlet flow. Thermostatic valves will NOT provide the desired accuracy outside of their flow capacity range. Minimum flows must be no less than shown (see Flow Capacities, page 9).

If installed on a recirculated hot water system, make certain the valve is piped according to Leonard Required Piping Method (see page 4 & 5).

REMEMBER! THIS IS A CONTROL DEVICE WHICH MUST BE CLEANED AND MAINTAINED ON A REGULAR BASIS. (SEE MAINTENANCE GUIDE AND RECORD, MGR-1000).

SETUP INSTRUCTIONS

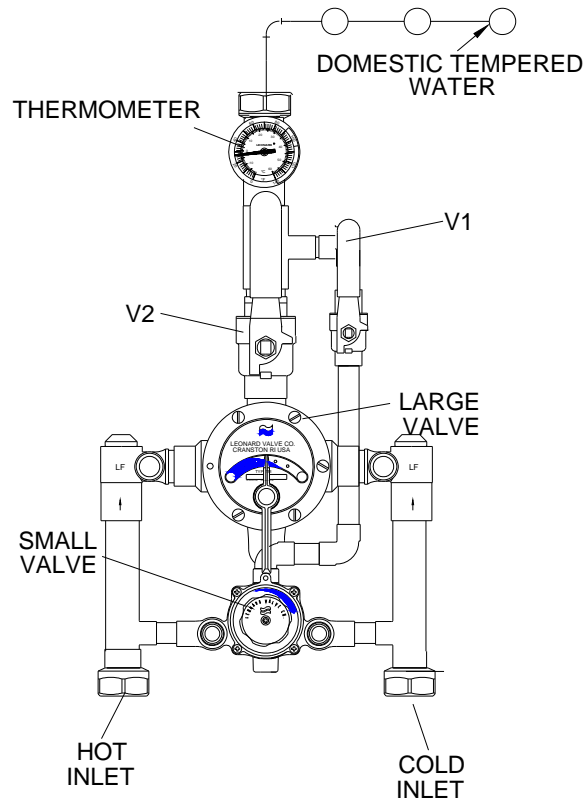

1. High-low Unit MUST be piped to correct piping method (see pages 4 & 5).
2. Make sure hot and cold supplies to this assembly are operating. The temperature of the hot water source must be properly set and maintained.
3. The circulator (if used) must be turned OFF before setup.
4. Turn on enough fixtures for a flow of at least * downstream from this system. Make sure each fixture is set to deliver full "HOT" water.
 - *8 GPM (30 l/min.) if TM valve is a TM-50 (Serial #52)
 - *13 GPM (45 l/min.) if TM valve is a TM-80 (Serial #82)
 - *13 GPM (45 l/min.) if TM valve is a TM-90 (Serial #92)
 - *18 GPM (68 l/min.) if TM valve is a TM-150 (Serial #152)
5. Close outlet Valve V1 at the smaller Type TM Valve.
6. Make sure valve V2 at the large Type TM Valve is in the full open position.
7. Set outlet temperature of the large Type TM Valve to the required level.
8. Open outlet Valve V1 at the small TM Valve.
9. Shut outlet Valve V2 at the large TM Valve.
10. Turn on enough fixtures for a flow at least 2 GPM downstream from this system. Make sure each fixture is set to deliver full "HOT" water.
11. Set outlet temperature of the small TM Valve to the same temperature as step 7.
12. Open outlet Valve V2. System is operational.
13. IMPORTANT!! See pages 4 & 5 to balance recirculation system.

*NOTE! FOR OPTIONAL OUTLET TEST CONNECTION, SEE PAGE 9.

REQUIRED METHOD OF PIPING (RECIRCULATED DOMESTIC WATER SYSTEMS)

METHOD #2

RECIRCULATING UP TO 8 GPM,
FOR FLOWS ABOVE 8 GPM SEE PAGE 5.

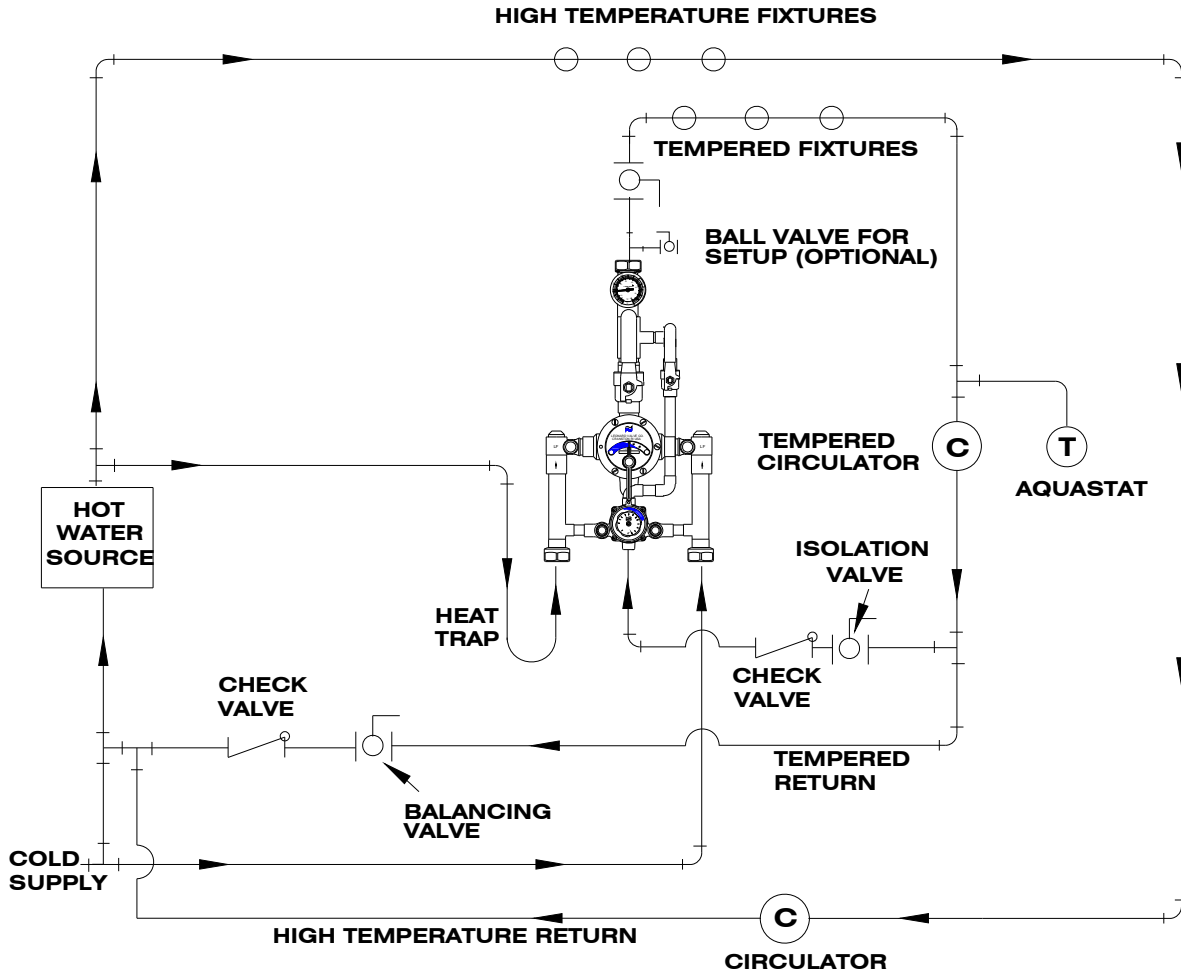

THIS PIPING METHOD IS NOT TO BE USED FOR MORE THAN ONE BUILDING

PROCEDURE TO BALANCE RECIRCULATION SYSTEM

1. MAKE SURE NO WATER IS BEING DRAWN IN THE BUILDING. OPEN BALANCING VALVE APPROXIMATELY HALF WAY AND START CIRCULATOR.
2. OBSERVE TEMPERATURE UNTIL IT STABILIZES.
3. CLOSE BALANCING VALVE SLIGHTLY IF TEMPERATURE IS TOO HOT, OR OPEN IT SLIGHTLY IF TEMPERATURE IS TOO COLD AND ALLOW TEMPERATURE TO STABILIZE. REPEAT UNTIL DESIRED RECIRCULATED TEMPERATURE IS SET.

REMEMBER! THIS IS A CONTROL DEVICE WHICH MUST BE CLEANED AND MAINTAINED ON A REGULAR BASIS (SEE MAINTENANCE GUIDE AND RECORD, MGR-1000).

METHOD #5

CIRCULATED FLOWS

GREATER THAN 8 GPM

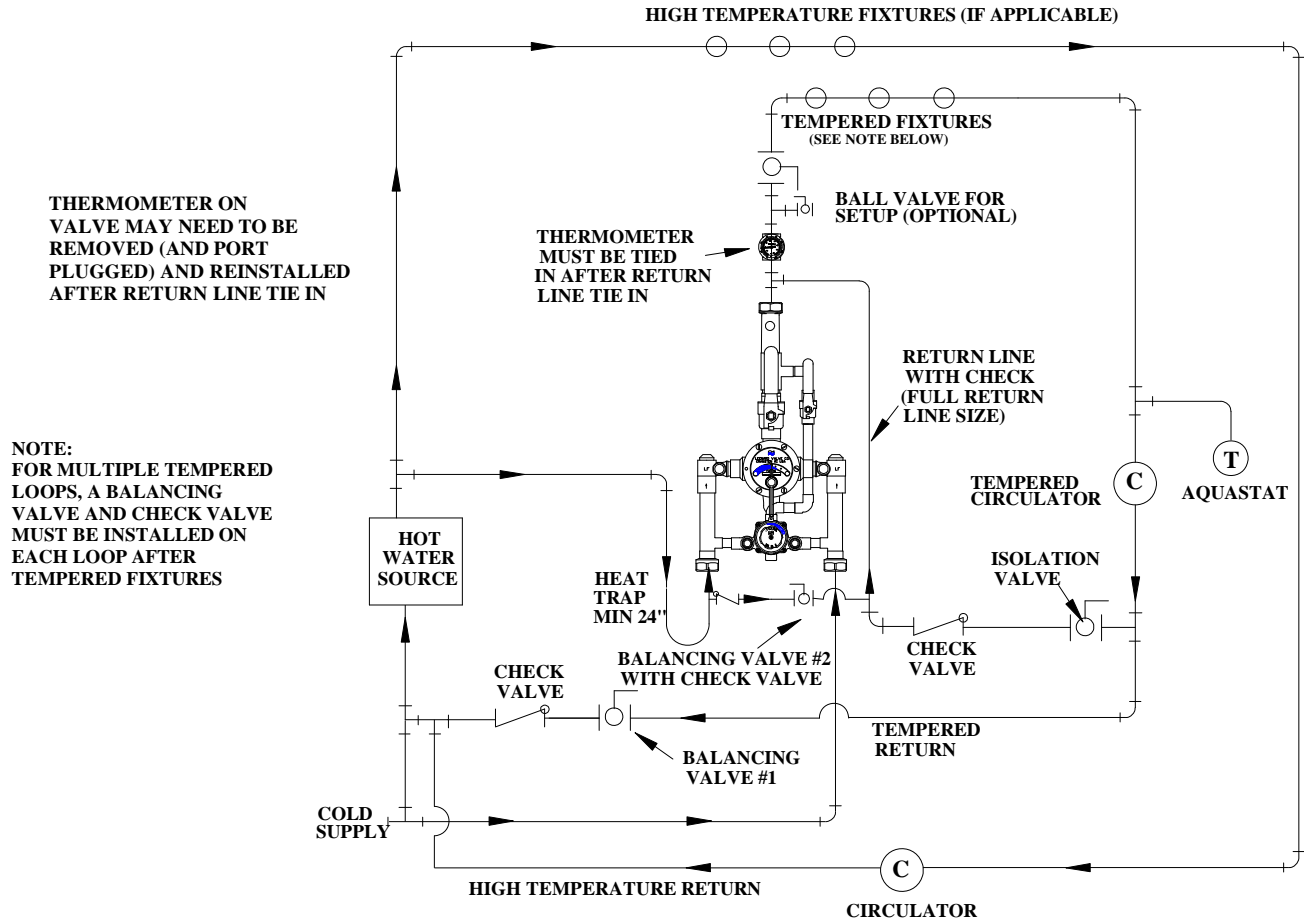

PROCEDURE TO BALANCE

1. MAKE SURE NO WATER IS BEING DRAWN IN THE BUILDING. OPEN BALANCING VALVE #1 APPROXIMATELY HALF WAY AND START CIRCULATOR. KEEP BALANCE VALVE #2 CLOSED AT THIS TIME.
2. OBSERVE TEMPERATURE UNTIL IT STABILIZES.
3. CLOSE BALANCING VALVE #1 SLIGHTLY IF TEMPERATURE IS TOO HOT, OR OPEN IT SLIGHTLY IF TEMPERATURE IS TOO COLD. ALLOW TEMPERATURE TO STABILIZE, REPEAT UNTIL DESIRED CIRCULATION TEMPERATURE IS SET.
4. IF UNABLE TO REACH DESIRED TEMPERATURE WITH VALVE #1 IN THE FULL OPEN POSITION, OPEN BALANCE VALVE #2 IN SMALL INCREMENTS (i.e. 1/8, 1/4, 3/8, ETC) UNTIL DESIRED TEMPERATURE IS ACHIEVED.

INSTRUCTIONS FOR SERVICING LARGER TM VALVE

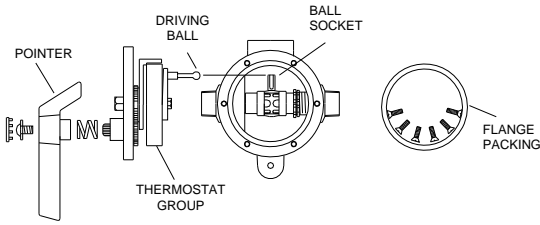

1. Shut off hot and cold supplies to this valve, loosen LTR set screw, remove snap cap, screw and washer, friction spring, remove pointer.
2. Remove, cover screws and cover, to which the thermostat group is attached.

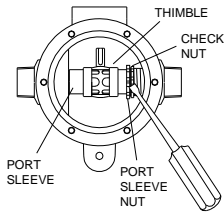

3. To clean port sleeve assembly (the thimble must slide freely on the port sleeve): unscrew the check nut as far as it will go, then screw the port sleeve nut into the base. The port sleeve and thimble may then be lifted out.
4. Clean with a non-corrosive cleaning solution. **DO NOT USE ABRASIVES!** The port sleeve should be reassembled in the valve with the shoulder to the left.
5. To clean thermostat group brush in a non-corrosive cleaning solution.
6. When reassembling, make sure driving ball of thermostat group engages the ball socket of the port sleeve assembly.

INSTRUCTIONS FOR SERVICING SMALLER TM 26 VALVE

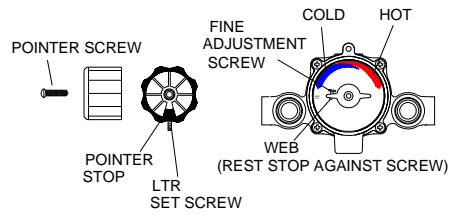

1. Loosen LTR set set screw.
2. Remove pointer screw, and pointer.
3. Turn off hot and cold supplies at screwdriver checkstops. Remove M20-2C cover screws to release cover and thermostat control assembly.

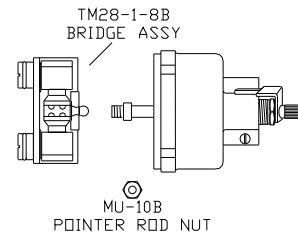

4. To remove bridge assembly, TM-28-1-8B, remove pointer rod nut (MU-10B) and pull bridge assembly off control rod.
5. To clean submerge bridge assembly in clean water or non-corrosive cleaning solution. **DO NOT USE ABRASIVES!** Be certain thimble moves freely on port sleeve. Note! Driving ball must engage slot in thimble when reassembling.
6. To clean thermostat group, loosen gland nut and remove cover. Brush in a non-corrosive cleaning solution.
7. To disassemble bridge assembly, see drawing next page (remove TM25-3A holder nuts with screwdriver in slots provided).

TROUBLESHOOTING INSTRUCTIONS

Note: Provide valve serial number when ordering parts for either valve!

		Large Valve (52,82)	Large Valve (92)	Large Valve (125)	Small Valve TM-26
PACKING & GASKETS	1. Leak between valve cover and base.	Repair Kit 1/50Y	Repair Kit 1/50Y	Repair Kit 1/125Y (125)	Repair Kit 1/26 (Packings & Gaskets)
PORT SLEEVE /BRIDGE ASSEMBLY	2. Valve delivers either all hot or all cold water, or will not mix consistently.	Repair Kit R/50	Repair Kit R/90	Repair Kit R/125	Repair Kit R/28 or TM-28-1-8B (bridge assembly)
THERMOSTAT GROUP	3. After cleaning or replacing port sleeve/bridge assembly, valve performance is not consistent.	Repair Kit R/50 or TGM-50	Repair Kit R/90 or TGM-90	Repair Kit R/125 or TGM-125	KIT#R/28 (rebuilding kit) Or TM28-G2 (thermostat group)
CHECKSTOPS	4. Hot water by-pass into cold line (or cold into hot). 5. Supplies cannot be shut off completely. Supplies leak at checkstop bonnets.	Repair Kit 2/50Y	Repair Kit 2/50Y	Repair Kit 2/50Y	Repair Kit 4/M20 (Checkstop Kit)

See pages 7 & 8 for parts Breakdowns

TM VALVE PARTS 1" INLET & LARGER

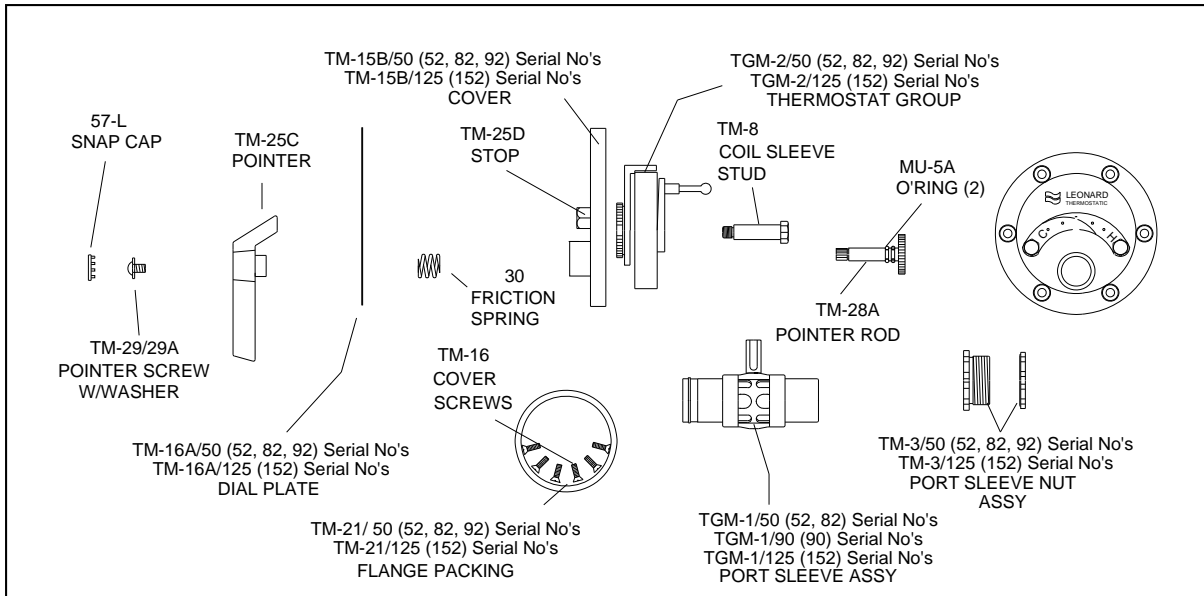

CHECKSTOP PARTS

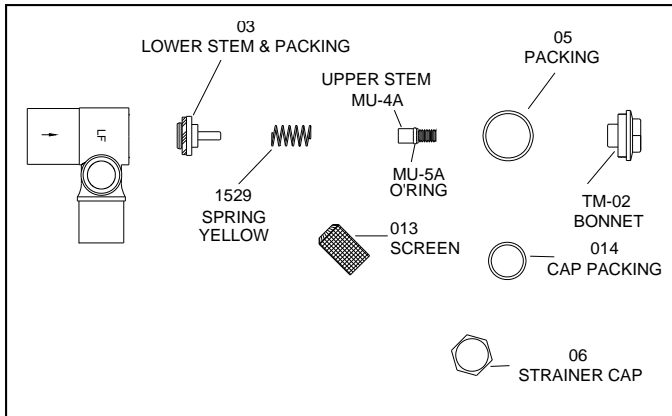

LOCK-TYPE POINTER

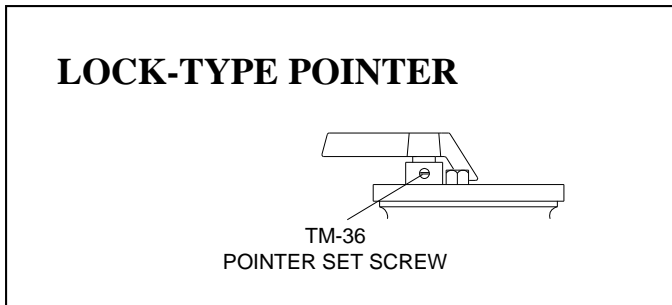

REPAIR KITS

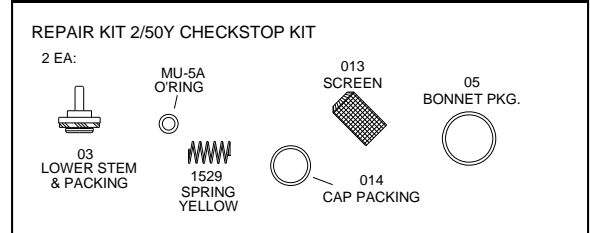
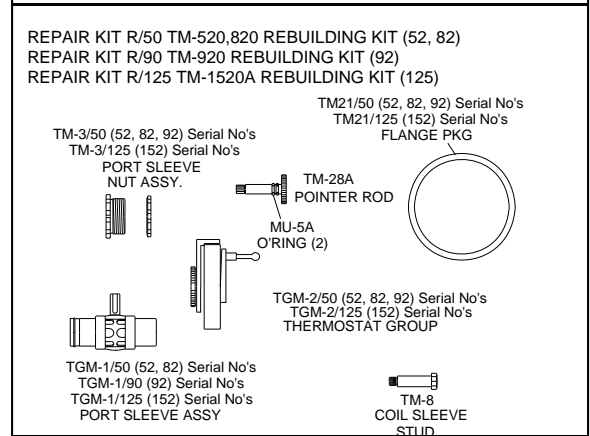
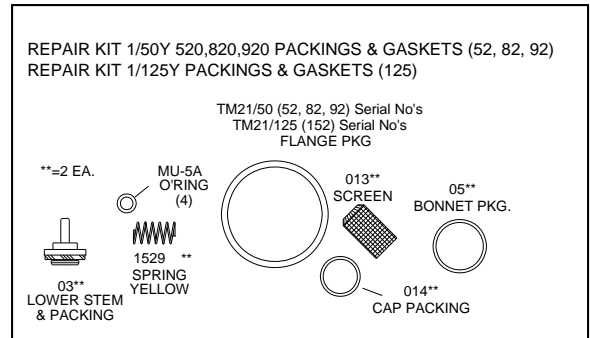

REMEMBER! THIS IS A CONTROL DEVICE WHICH MUST BE CLEANED AND MAINTAINED ON A REGULAR BASIS. SEE MAINTENANCE GUIDE AND RECORD MGR-1000.

NOTE: AFTER INSTALLING NEW PARTS IT WILL BE NECESSARY TO RESET THE ADJUSTABLE HIGH TEMPERATURE LIMIT STOP ON EACH VALVE (SEE PAGE 2).

TM-26 VALVE PARTS (BOTTOM VALVE)

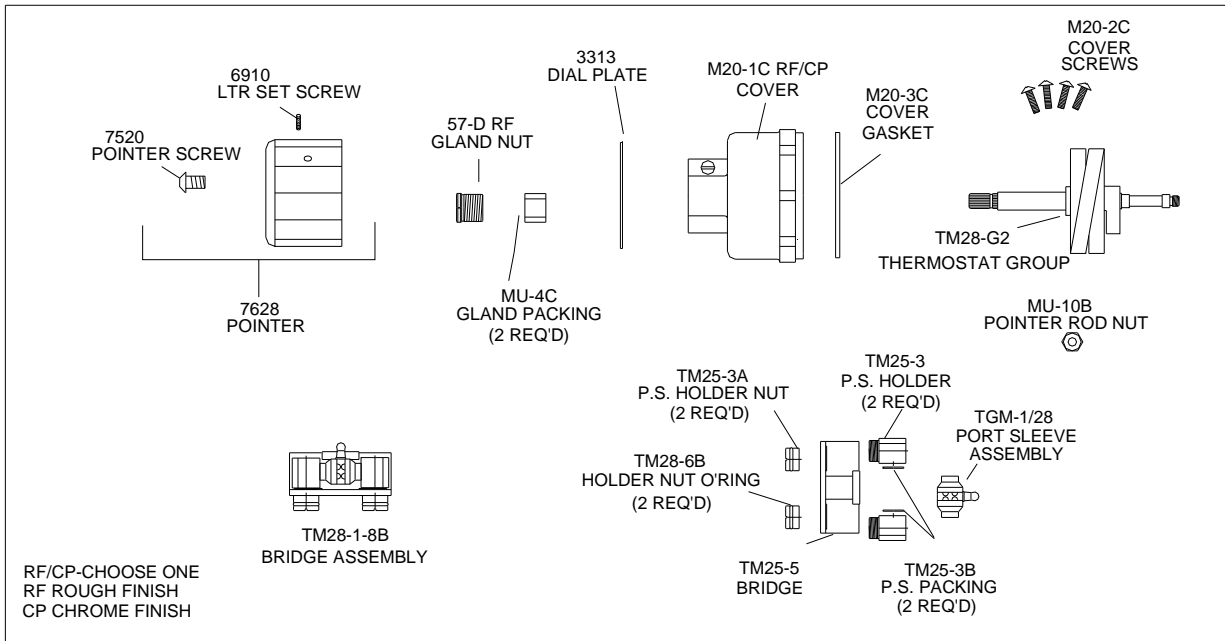

REPAIR KITS

CHECKSTOP PARTS

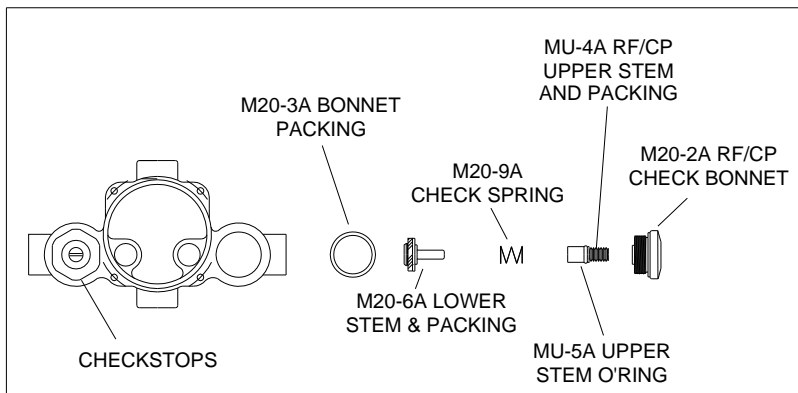

KIT 1/26 PACKINGS & GASKETS

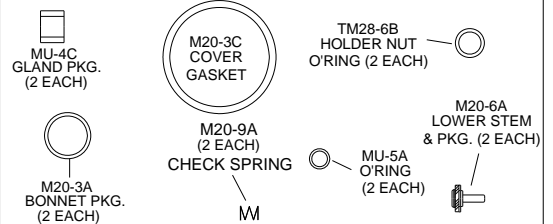

KIT R/28 REBUILDING KIT

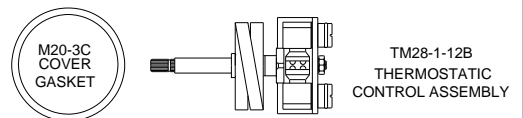

KIT 4/M20 CHECKSTOP KIT

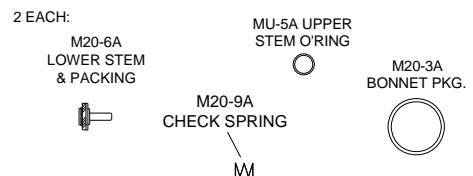

REMEMBER! THIS IS A CONTROL DEVICE WHICH MUST BE CLEANED AND MAINTAINED ON A REGULAR BASIS (SEE MAINTENANCE GUIDE AND RECORD).

NOTE: AFTER INSTALLING NEW PARTS IT WILL BE NECESSARY TO RESET THE ADJUSTABLE HIGH TEMPERATURE LIMIT STOP ON EACH VALVE (SEE PAGE 2).

**OPTIONAL OUTLET TEST CONNECTION
(BY OTHERS)**

The addition of this piping arrangement (extra tee and ball valve) eliminates the need to turn showers on and off throughout the building at setup. The flows required in the setup instructions (page 3) are set by using Ball Valve A. (make sure main outlet ball valve is closed).

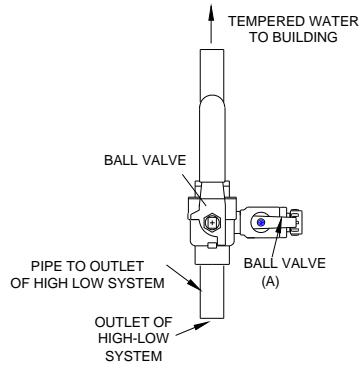

CAUTION! ALL THERMOSTATIC WATER MIXING VALVES AND SYSTEMS HAVE LIMITATIONS! THEY WILL NOT PROVIDE THE DESIRED PERFORMANCE OUTSIDE OF THEIR FLOW CAPACITY RANGE! CONSULT THE CAPACITY CHART BELOW AND OBSERVE MINIMUM FLOWS SHOWN.

FLOW CAPACITIES

MODEL	IN	OUT	MINIMUM FLOW (GPM) (l/min)	SYSTEM PRESSURE DROP (PSIG)										
				5	10	15	20	25	30	35	40	45	50	PSI
				,3	.7	.97	1.4	1.7	2.1	2.4	2.8	3.1	3.4	BAR
TM-520B-LF	3/4"	1"	1.0 (3.7)	19 72	29 110	38 144	45 170	51 193	56 212	62 235	68 257	72 272	75 284	GPM l/min
TM-820B-LF	1"	1 1/4"	1.0 (3.7)	26 98	40 151	48 182	58 220	63 238	68 257	74 280	79 299	84 318	89 337	GPM l/min
TM-920BLF	1 1/4"	1 1/4"	1.0 (3.7)	33 98	47 151	56 212	63 220	68 238	82 257	85 280	92 299	103 318	115 337	GPM l/min
TM-1520B-LF	1 1/4"	1 1/2"	1.0 (3.7)	48 182	65 246	80 303	95 360	112 424	120 454	130 492	140 530	158 598	165 625	GPM l/min

LIMITED WARRANTY

Leonard Valve Company (hereinafter, "Leonard") warrants the original purchaser that products manufactured by Leonard will be free from defects in material or workmanship under normal conditions of use, when properly installed and maintained in accordance with Leonard's instructions, for a period of one year from the date of shipment. During this period, Leonard will at its option repair or replace any product, or part thereof, which shall be returned, freight prepaid, to the Leonard factory and determined by Leonard to be defective in materials or workmanship. Leonard provides no warranty, express or implied, which extends beyond the description contained herein. LEONARD SPECIFICALLY DISCLAIMS ANY AND ALL IMPLIED WARRANTIES OF MERCHANTABILITY OR OF FITNESS FOR A PARTICULAR PURPOSE. Nonetheless, some jurisdictions may not allow the disclaimer of certain implied warranties, in which case Leonard hereby limits such implied warranties to the duration of the limited warranty period contained herein. Some jurisdictions may not allow limitations on how long an implied warranty lasts, so the foregoing durational limitation may not apply to you. In no event will Leonard be liable for labor or incidental or consequential damages. Any alteration or improper installation or use of this product will void this limited warranty. If any provision of this limited warranty is prohibited by law in the applicable jurisdiction, such provision shall be null and void, but the remainder of this limited warranty shall continue in full force and effect.